

Data Sheet



Article number: 25110267002

Description: ICME Single-phase motor MD80 BL2 1,1KW
2 - 2800 rpm 1x230 Volt 50Hz B3/B5 with starting & running capacitor

Measures

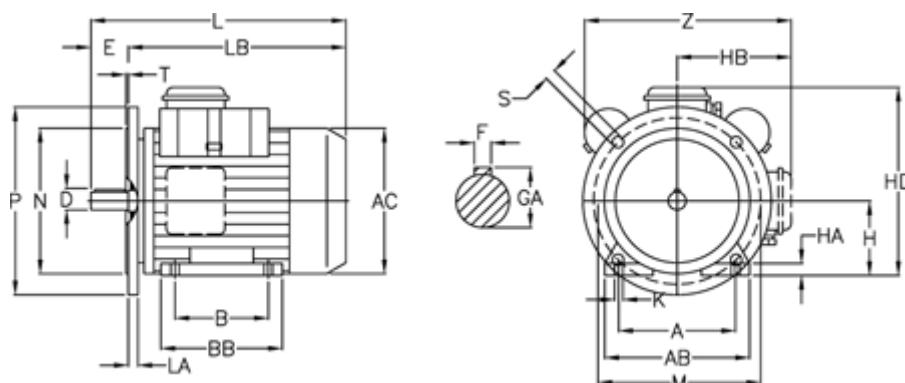

A = 125	H = 80	N = 130
AB = 155	HA = 13	P = 200
AC = 156	HB = 122	S = 11.5
B = 100	K = 9	T = 3.5
D = 19	L = 305	Z = 230
E = 40	LA = 12	
F = 6	LB = 265	
GA = 21.5	M = 165	